













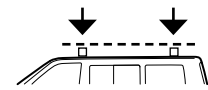

Cruzber S.A., ES-A14018311
P.I. Las Salinas II, E-14960 Rute
www.cruzber.com







- (E)** **Instrucción de montaje**
¡Leer primero!
- (GB)** **Assembly instructions**
Read first!
- (F)** **Instruction de montage**
Lire en premier!
- (D)** **Montageanleitung**
Zuerst lesen!
- (PT)** **Instruções de montagem**
Ler primeiro!
- (PL)** **Instrukcja montażu**
Najpierw przeczytaj!
- (CZ)** **Montážní návod**
Čtěte pozorně!
- (HU)** **Szerelési Utasítás**
Először olvasd el!
- (RO)** **Instructiuni de montaj**
Intai cititi!
- (HR)** **Detaljne upute**
Prvo pročitati!
- (GR)** **Διαβάστε προσεκτικά τις**
Οδηγίες Συναρμολόγησης!
- (TR)** **Öncelikle montaj:**
Talimatlarını okuyunuz!
- (RU)** **Инструкции по монтажу**
Сначала прочитайте!
- (IT)** **Istruzioni di montaggio**
Leggere per primo!
- (NL)** **Montagehandleiding**
Eerst lezen!

- Barras de aluminio
- Aluminium bars
- Barres d'aluminium
- Aluminiumdachträger
- Barras d'alumínio
- Belki aluminiowe
- Hliníková sada tyčí
- Aluminium rudak
- Aluminijske šipke
- Bare din aluminiu
- Μπάρες Αλουμινίου
- Alüminyum barlar
- Алюминиевые поперечины
- Barre di alluminio
- Aluminium dakdragers

Código Code Code Kode	924-329		
	Lv 6 2011 - r 5		
Modelo Model Modèle Modell	Alu-Cargo		
Lote Lot Lot Lot	03 -11	Peso Weight Poids Gewicht	4,30 kg
  			
 		Max: 100 kg	
			
Código Homologación CEE EEC Type Approval Number e9*74/483*2007/15*3024			

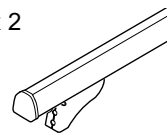
	1°		
	2°		
			

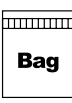
- (E)** **Contenido embalaje:** ¡Verificar!
- (GB)** **Package content:** Check!
- (F)** **Contenu d'emballage:** Vérifier!
- (D)** **Packungsinhalt:** Überprüfen!
- (PT)** **Contéudo embalagem:** Verificar!
- (PL)** **Zawartość opakowania:** sprawdzić!
- (CZ)** **Obsah balení:** Zkontrolujte!
- (HU)** **Csomag tartalma:** Ellenőrizd!
- (RO)** **Pachetul contine:** Verificati!
- (HR)** **Sadržaj paketa:** Provjeri!
- (GR)** **Ελέγξτε το περιεχόμενο:** του πακέτου!
- (TR)** **Paket içeriğini:** Control ediniz!
- (RU)** **Содержание упаковки:** Проверьте!
- (IT)** **Contenuto della confezione:** Controllare!
- (NL)** **Pakket inhoud:** Controleer!

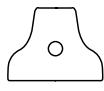
x 1 	x 1 	x 2  (824-010) 118 cm	x 4  2x (012-029) 2x (012-056)
x 2  1x (810-064) 1x (805-023)	x 4  2x (817-539) 1x (817-535) 1x (817-536)	x 4  2x (813-062) 2x (813-063)	

Código
Code
Code
Kode

924-329

Lv6 2011-r5

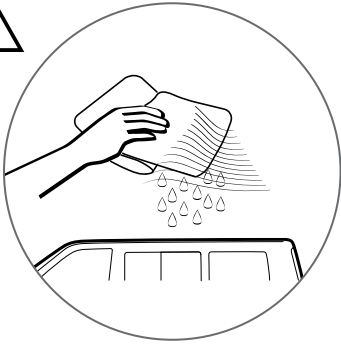

1

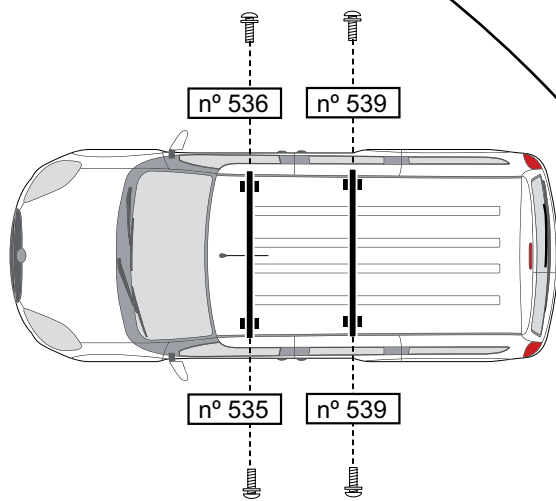
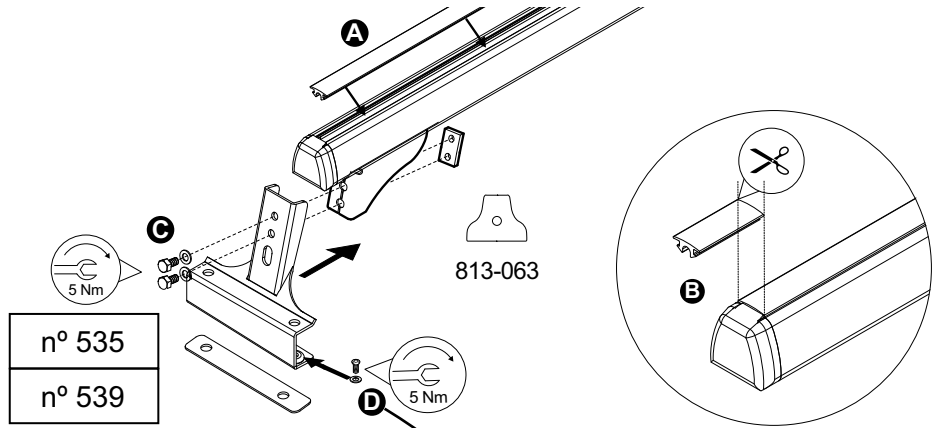
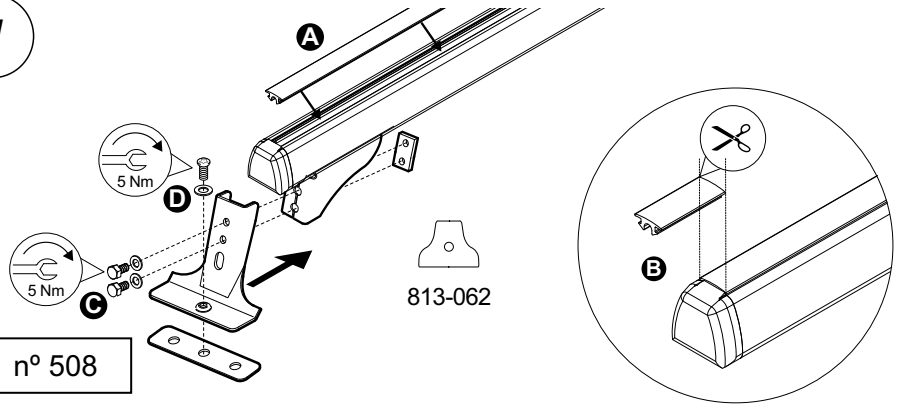

2

