













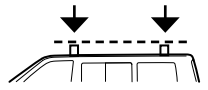

Cruzber S.A., ES-A14018311
P.I. Las Salinas II, E-14960 Rute
www.cruzber.com





- (E)** **Instrucción de montaje**
¡Leer primero!
- (GB)** **Assembly instructions**
Read first!
- (F)** **Instruction de montage**
Lire en premier!
- (D)** **Montageanleitung**
Zuerst lesen!
- (PT)** **Instruções de montagem**
Ler primeiro!
- (PL)** **Instrukcja montażu**
Najpierw przeczytaj!
- (CZ)** **Montážní návod**
Čtěte pozorně!
- (HU)** **Szerelési Utasítás**
Először olvassd el!
- (RO)** **Instructiuni de montaj**
Intai cititi!
- (HR)** **Detaljne upute**
Prvo procitati!
- (GR)** **Διαβάστε προσεκτικά τις**
Οδηγίες Συναρμολόγησης!
- (TR)** **Öncelikli montaj:**
Talimatlarını okuyunuz!
- (RU)** **Инструкции по монтажу**
Сначала прочитайте!
- (IT)** **Istruzioni di montaggio**
Leggere per primo!
- (NL)** **Montagehandleiding**
Eerst lezen!

- Barras de acero
- Steel bars
- Barres d'acier
- Stahldachträger
- Barras d'aço
- Belki stalowe
- Ocelové střešní nosiče
- Acél rudak
- Čelične šipke
- Bare din otel
- Μπάρες Σιδερέ
- Çelik barlar
- Стальные поперечины
- Barre d'acciaio
- Stalen dakdragers

Código Code Code Code Code	922-409		
	Lv 6 2011 - r9		
Modelo Model Modèle Modell	30x20x1,5		
Lote Lot Lot Lot	06 -10	Peso Weight Poids Gewicht	6,10 kg
  			
 		Max: 150 kg	
			
Código Homologación CEE EEC Type Approval Number e9*74/483*2007/15*3024			

	1°		
	2°		
			

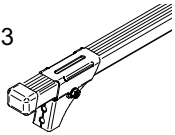
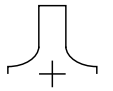
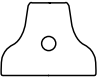
- (E)** **Contenido embalaje:** ¡Verificar!
- (GB)** **Package content:** Check!
- (F)** **Contenu d'emballage:** Vérifier!
- (D)** **Packungsinhalt:** Überprüfen!
- (PT)** **Contéudo embalagem:** Verificar!
- (PL)** **Zawartość opakowania:** sprawdzić!
- (CZ)** **Obsah balení:** Zkontrolujte!
- (HU)** **Csomag tartalma:** Ellenőrizd!
- (RO)** **Pachetul contine:** Verificati!
- (HR)** **Sadržaj paketa:** Provjeri!
- (GR)** **Ελέγξτε το περιεχόμενο:** του πακέτου!
- (TR)** **Paket içeriğini:** Control ediniz!
- (RU)** **Содержание упаковки:** Проверьте!
- (IT)** **Contenuto della confezione:** Controllare!
- (NL)** **Pakket inhoud:** Controleer!

x 1 	x 1 	x 3  (823-323) 120 cm	x 6  2x (817-508) 2x (817-530) 2x (817-531)
x 6  (813-062)	x 2  1x (810-009) 1x (805-012)		

Código
Code
Code
Kode

922-409

Lv6 2011-r9

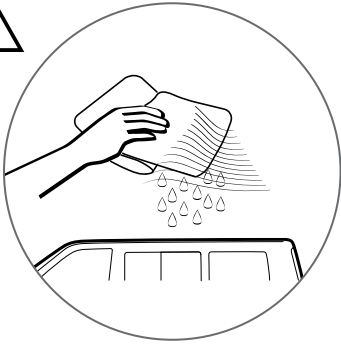

1

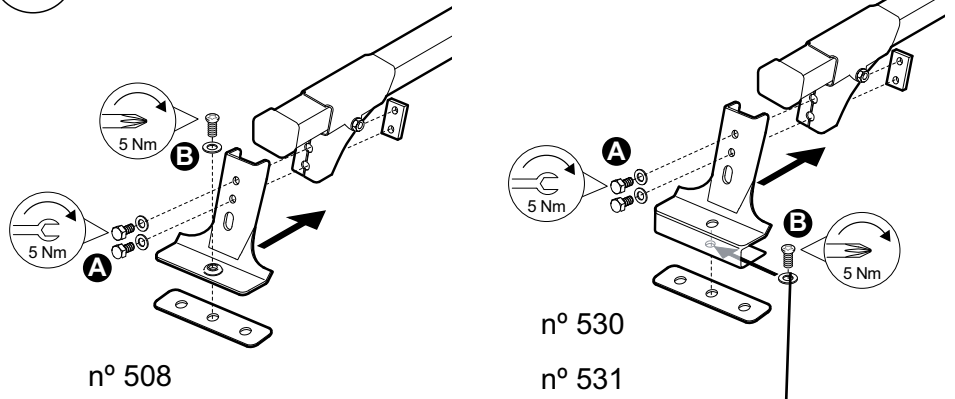

2

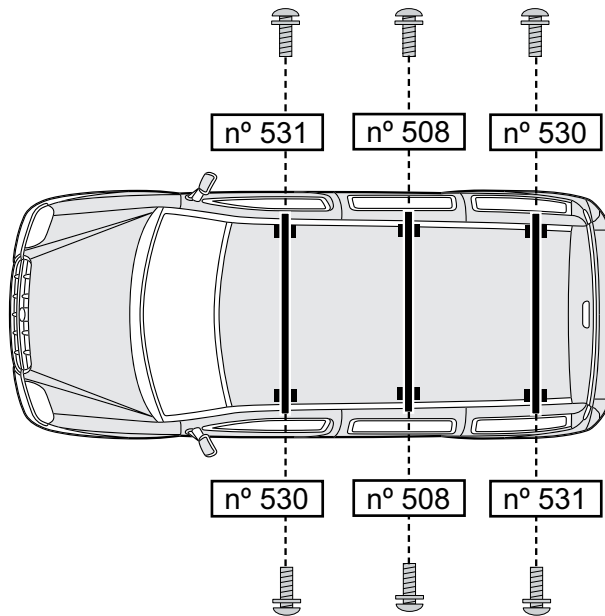

3

